

# The Ersa soldering primer

## Soldering made easy

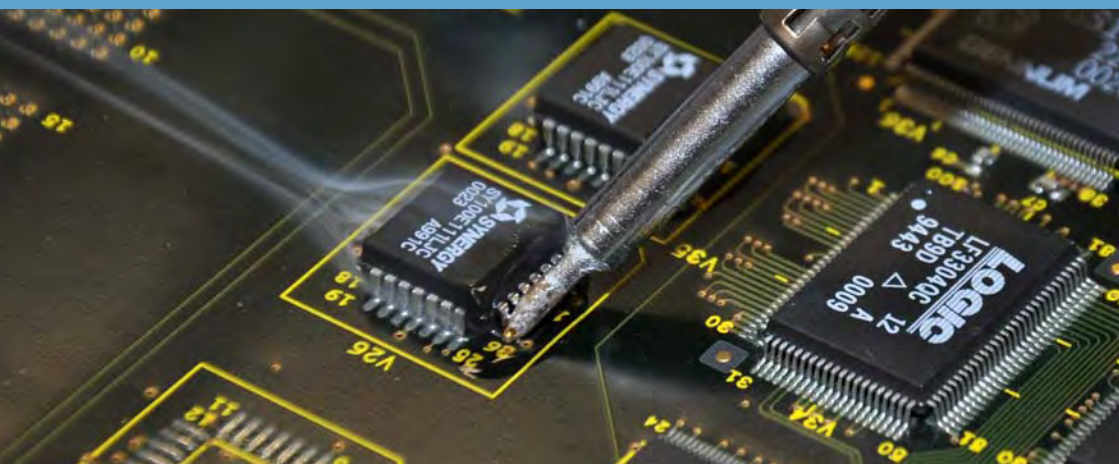

# Soldering – a never-ending story

for more than 5,000 years already

Man had scarcely learned how to use metals for his purposes when the desire to join them arose in him. Many of the pieces of jewelry, tools and weapons we know from the Bronze Age owe their usefulness and beauty to the art of soldering.



Today, it is difficult to say who first discovered how to "glue" metals. One thing is certain - the goldsmiths of ancient Egypt knew how to join gold and silver already more than 5,000 years ago. Their colleagues in Troy were also master craftsmen long before the ancient Teutons could even dream of such handicraft. Soldering really "came of age" when tin was discovered



as a joining metal. And that was, after all, already 4,000 years ago!

From then on, soldering technology was on its way. It first spread around the Mediterranean. The Cretans showed it to the Etruscans who then taught it to the Romans, Tunisians, Spaniards, followed by many others, including the less developed cultures of the time – the Swiss, Bohemians, Hungarians, Teutons and Scandinavians. From culture to culture, from generation to generation, the craft of soldering was continuously improved and refined.

The ancient Romans already laid down and soldered 400 km of leaden water pipes, conjured up stoves and bathtubs from bronze sheets, not to mention the excellent craftsmanship of their armorers and goldsmiths. Apart from craftsmanship in soldering, our understanding of the science of soldering has grown and has been refined over the centuries.

Today, soft soldering in the electronics industry has developed into a full-fledged production technology, encompassing the fields of mechanics, chemistry, physics and metallurgy. Ernst Sachs, the founder of Ersa (the company name consists of the initial letters of his first and last name) contributed to this development. In 1921 he developed the first electrically operated soldering iron for the industry that was manufactured in series. Since that time, Ersa has committed itself to the further development and perfection of soldering technology with great passion and extending its full power of innovation.

Today, Ersa stands for the most comprehensive product range in the soft soldering technology worldwide and for more than 90 years of industry experience and innovation, know-how and highest product quality.

The Ersa soldering iron product range covers ultra-fine soldering tips, classical soldering irons powered from the standard power net and special soldering tools up to the 550 W hammer soldering iron. Ersa's electronically temperature-controlled soldering stations represent the industry standard, as does the extensive range of rework and

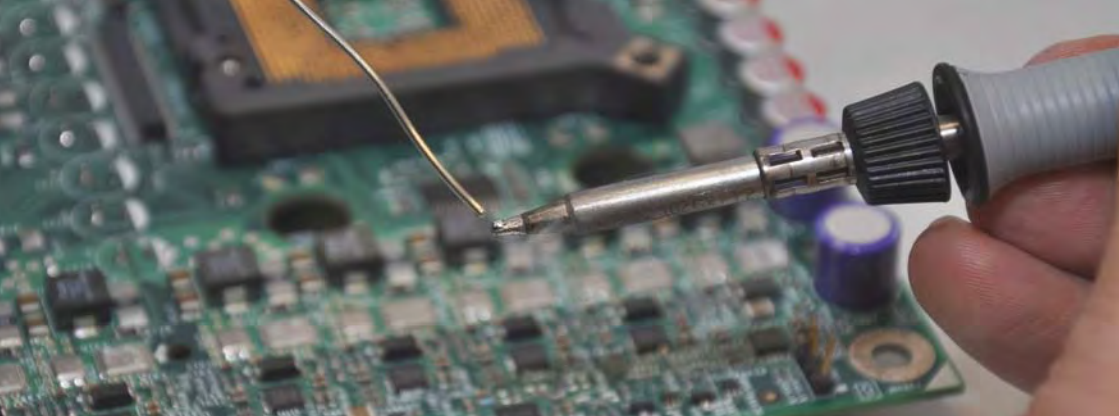

inspection systems, wave-, reflow- and selective soldering systems. The line of Ersa screen printers complements the product range.

Ersa's quality soldering tools are used in the hobby area, such as, for example, in model-making or tiffany

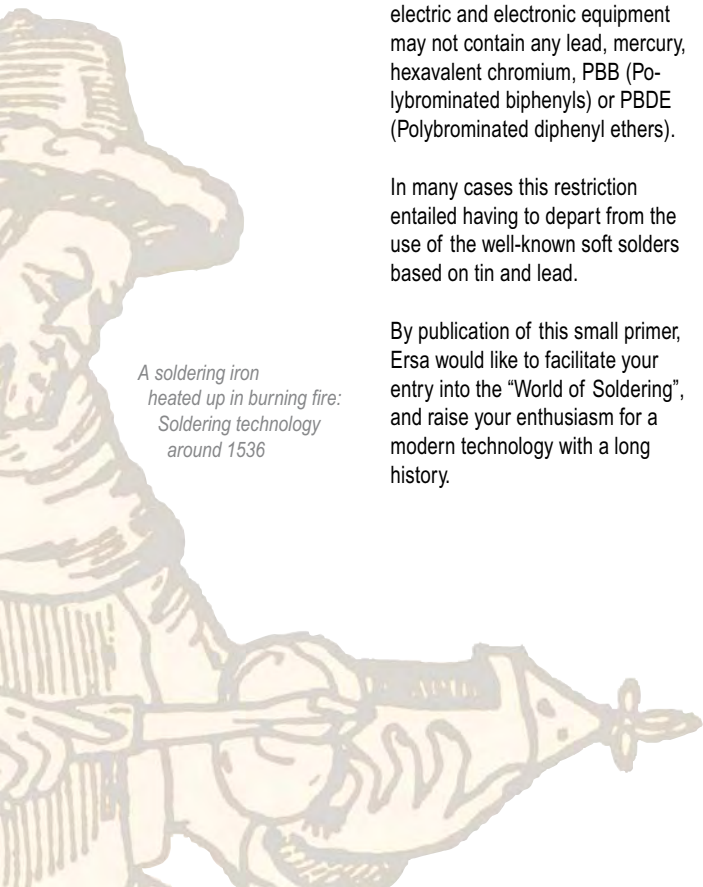

*A soldering iron heated up in burning fire: Soldering technology around 1536*

soldering, in the craft sector, in laboratories and in industrial electronic manufacturing.

New challenges for the soldering technology were raised by the ban on certain hazardous substances (RoHS) in 2006. Since 1 July 2006 electric and electronic equipment may not contain any lead, mercury, hexavalent chromium, PBB (Polybrominated biphenyls) or PBDE (Polybrominated diphenyl ethers).

In many cases this restriction entailed having to depart from the use of the well-known soft solders based on tin and lead.

By publication of this small primer, Ersa would like to facilitate your entry into the "World of Soldering", and raise your enthusiasm for a modern technology with a long history.

## Content

|  | Page |
|--|------|
| The history of soldering                         | 2    |
| The art of soldering                             | 5    |
| What is needed to solder?                        | 6    |
| Health   | 9    |
| THT soldering                                    | 10   |
| SMD soldering                                    | 13   |
| BGA soldering / rework                           | 16   |
| Miniature and microsoldering irons               | 18   |
| Universal, standard and hammer soldering irons   | 19   |
| High-speed soldering irons                       | 20   |
| Gas soldering irons                              | 21   |
| Soldering stations                               | 21   |
| Multifunctional soldering & desoldering stations | 23   |
| Hybrid rework station                            | 26   |
| Solder fume extractions                          | 27   |
| Tiffany soldering                                | 28   |
| Accessories                                      | 30   |
| Seminars, references                             | 31   |



# Solder joints hold the world together

Connecting pacemakers and solar parks

To imagine today's world without soft soldering is not possible. It is the means to fabricate safely functioning, electrically conducting connections. Regardless of whether we talk about power technology, drive technology, telecommunications, automation or electronic controls – in all those fields soldered connections have a decisive share that everything functions in a way as has been foreseen and planned by the developers and



visionaries of the products. Today soft soldering is such a common place occurrence, that no one wastes any further thought on it. Daily we take use of our computers, mobile phones and play stations for granted, the modern comforts provided for by electronics found in modern automobiles is expected as a matter of course, and we fly – privately or on business – to the farthest spots in the world.

Consequential damage because of the failure of a solder joint in an iPod is relatively limited. It is a different matter altogether, though, if the electronics in an airplane full of vacationers, in a space shuttle, or in an implanted pacemaker fails.



Such failures are immanently life-threatening. But not to worry – the highest quality demands apply for those applications, and rightfully so!

Aside from soldering in consumer electronic products, there are numerous other applications such as, to name but a few, alternative power generation with wind turbines or solar parks, R&D departments and in work performed by craftsman such as electricians and plumbers. Let us not forget the many part-time and hobby users for whom there are no limits curtailing their phantasies and artistic freedom when handling a soldering iron and solder.



# The art of soldering

## What's behind it?

In a soldering process two metal parts are joined by means of a molten metallic bonding agent (solder), whereby the melting point of the bonding agent is always lower than that of the metal parts to be joined. If the melting point is below 450 °C, then it is a soft soldering process, if it is above, it is called hard soldering or brazing. Welding, on the other hand, is the process where two metals will be heated up to their melting point, at which time they will, together with a filler material, form a pool of molten

material causing coalescence. In soft soldering, the seams between the metals to be joined will be filled with a tin alloy. It is important that the alloy does not simply stick to the foreign metals' surface after cooling but unites with the metal. For this purpose, a

small quantity of the foreign metals must dissolve and unite with the tin alloy forming a mix of crystals – the so called diffusion zone. That is the task of the tin, whereas the alloy's other components are responsible for the solder liquefaction and the joint's mechanical stability. A solder joint consists of the following layers:

- ① Base metal
- ② Diffusion zone
- ③ Solidified solder
- ② Diffusion zone
- ① Base metal

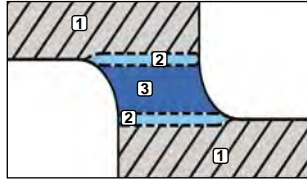

Cross section of a solder joint

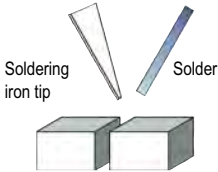

The prepared parts and the solder are heated



The liquid solder flows into the gap and fills it



The solidified solder joins the parts together

To achieve the highest mechanical stability, i.e. to assure the durability of the solder joint, the diffusion zone may neither be too thick nor too thin. Its ideal thickness is

0.5 µm. The formation of the diffusion zone depends on the temperature, the solder time and the alloy used. If the diffusion zone is too thick, the solder joint will be brittle

and porous, whereas the formation of a zone which is too thin indicates that an insufficient connection or no mechanical connection at all has been formed.

## Reaction of the flux during manual soldering on a PCB using flux cored solder wire

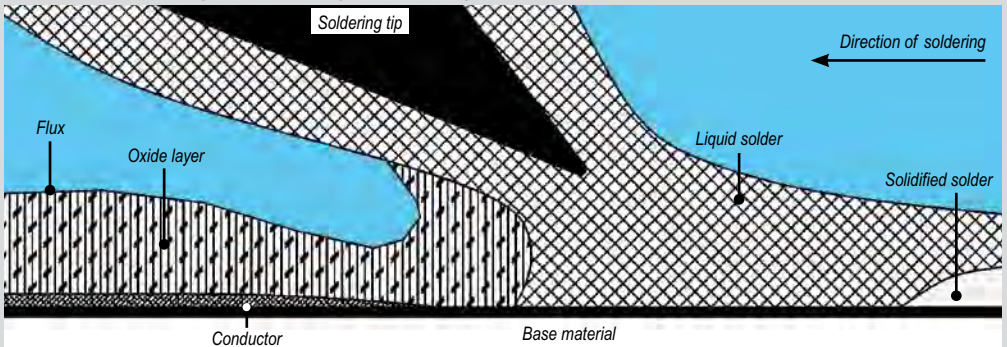

# What do you need for soldering?

The basics – the 5 essential factors

## 1. The soldering iron

to provide the heat required



Heat is required to melt the solder. This is the soldering iron's job.

Temperatures of 200 °C – 450 °C are required depending on solder joint and solder alloy. In the field of electronics, the usual temperature lies between 250 °C and 375 °C.

In order to have the proper temperature for any soldering application,

the soldering iron's thermal output and an efficient heat transfer to the solder joint to be made is decisive.

One either selects a soldering iron that performs within the temperature range required, or a soldering station with temperature control is used. Temperature-controlled soldering stations enable the user to work on different applications without loss of solder joint quality,

because of the precise control of the preset temperature at the soldering iron tip.

Both the soldering station's registration of the actual tip temperature should be highly precise, and the heating element should be powerful and recover quickly in order to avoid over-heated or cold solder joints.

**380 °C**

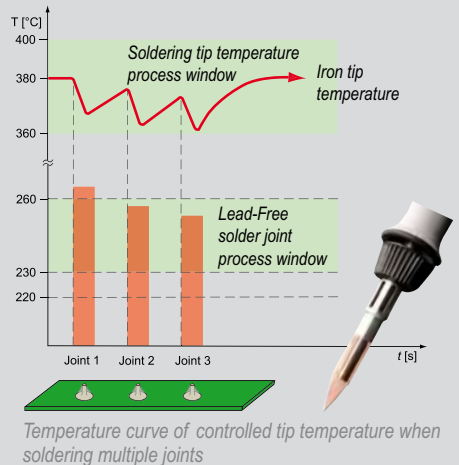
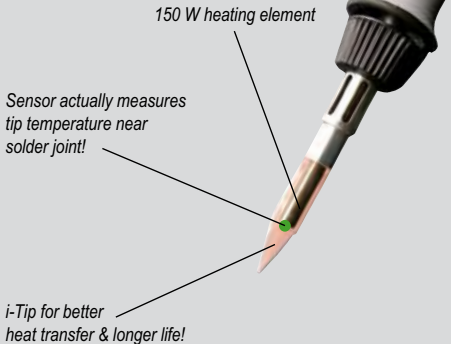

## 2. The soldering tip

to transfer the heat from the heating element to the tip

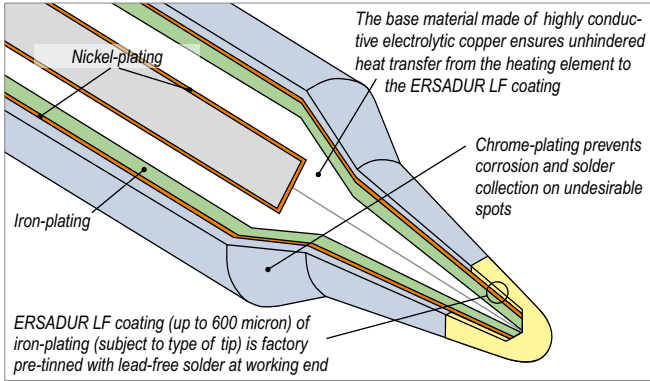

Cross-section of an ERSADUR soldering tip, non-scale representation

The soldering tip is the “heart” of the soldering iron, and responsible for the heat transfer from the heating element via the solder to the solder joint. Depending on the soldering iron and the application, different types of tips are available. Prerequisites for good solder joints are the correct soldering iron tip shape, perfect heat transfer, a good condition of the tip and a reliable performance over time. In addition, the soldering tip has to convey also the necessary amount of sensitivity back to the operator.

### How to take solder joint quality to its peak – ERSADUR long-life soldering tips

Traditional soldering tips are made of copper which conducts heat well and is inexpensive, but the tip oxidizes heavily when heated and releases copper particles into the solder until it has been “corroded” entirely. To maintain the tip in operational shape, it requires intensive care. Today, only coated soldering tips are used in electronics production - the largest field of application for soft soldering.

ERSADUR long-life tips have been conceived for continuous operation and for high-quality results. They are galvanically plated with an iron coating and protected against corrosion and oxidation by an additional chrome layer in a very special manufacturing process, developed and used exclusively by Ersa. And their perfect thermal conductivity protects the heating element from overheating and premature wear. Ersa offers

a comprehensive range of soldering tips for the diverse requirements.

Proper tip care increases tip lifetime considerably:

- Never clean the long-life tip before putting the soldering iron into its holder, since the solder remaining on the tip prevents oxidation of the solder track.
- Always keep the long-life soldering tip covered with solder, as otherwise it becomes passive and will no longer wet properly.

Passive tips can be reactivated by the application of the lead- and halogen-free Ersa Tip Reactivator. All that is needed is to wipe the hot tip on the surface of the regeneration compound. Furthermore, the hot tips should regularly be cleaned with a moist viscose sponge before soldering. Alternatively the tips can

be dry cleaned using the Ersa “dry sponge”, a sponge made of special metal wool. Dry cleaning has proven to be advantageous in lead-free soldering. The soldering tips are not cooled abruptly, and contaminated tips resulting from dirty sponges are avoided. Due to the slightly abrasive properties of the special wire mesh, passive layers that accumulated on the tip can easily be removed. Tip life is thus increased considerably in lead-free hand soldering.

*Ersa Tip Reactivator. A comprehensive range of accessories is available at [www.ersa.com](http://www.ersa.com)*



# What do you need for soldering?

The basics – the 5 essential factors

## 3. The solder

for the connection

Metallic bonding agents (solders), mostly in the shape of a wire or a bar, are available as diverse alloys.

Soft solders consisted mostly of a mix of tin (Sn) and lead (Pb). Since the implementation of the RoHS directives on 01 July 2006 the use of solders containing lead is prohibited. Lead-free solders are usually alloys containing silver (Ag) and copper (Cu).

The alloy's composition determines melting temperature and physical properties of the joint. Criteria for the choice of an alloy are: production process, specification of the product, field of application, cost of the alloy.

Prerequisites for good soldering results are:

- ▼ Suitable soldering iron
- ▼ Suitable fluxes
- ▼ Clean surfaces of where to solder
- ▼ Suitable solder alloy
- ▼ Sound soldering tip
- ▼ Correct soldering time



Solder wire with one or with multiple flux cores

## 4. The flux

for the ability to wet

Fluxes are used to attain the best possible bonding between solder and metal. They provide for metallicly clean surfaces of the parts to be soldered, remove the oxides as well as other flow-inhibiting contaminations and prevent the formation of new oxides during the soldering process. A difference is

made between acidic (as used in plumbing) and acid-free products (as used in electrical and electronic applications). It is most common to use solder wire with one or more flux cores in electronics production, whereas bar solder is the form of choice in plumbing as well as in the radiator and auto body work.

### Examples of some common alloys

| Alloy         | Flux type  | Melting point / range |
|---------------|--|-----------------------|
| L-Sn60Pb40    | EN 29454/1.1.2 (F-SW 26/DIN 8511)                  | 183 °C – 190 °C       |
| L-Sn60Pb38Cu2 | EN 29454/1.1.2 (F-SW 26/DIN 8511)                  | 183 °C – 190 °C       |
| L-Sn63Pb37    | EN 29454/1.1.3 (F-SW 32/DIN 8511), free of halogen | 183 °C eutectic       |
| L-Sn62Pb36Ag2 | EN 29454/1.1.3 (F-SW 32/DIN 8511), free of halogen | 178 °C – 190 °C       |

### Alloy – lead-free / complying RoHS-WEEE

|                    |  |                 |
|--------------------|--|-----------------|
| L-Sn95,5Ag3,8Cu0,7 | EN 29454/1.1.2 (F-SW 26/DIN 8511)                  | 217 °C eutectic |
| L-Sn96,5/Ag3,5     | EN 29454/1.2.3 (F-SW 33/DIN 8511), free of halogen | 221 °C eutectic |
| L-Sn99,3Cu0,7      | EN 29454/1.2.3 (F-SW 33/DIN 8511), free of halogen | 227 °C eutectic |





## 5. A safe and clean working environment

to ensure quality and health

Safety first, especially while soldering. The VDE and GS emblems ensure the electrical safety of soldering equipment. The use of the VDE sign obligates the manufacturer to monitor production accordance with test guidelines and to conduct tests according to the regulations determined by the VDE testing institute.



Fully equipped workplace with i-CON1 C soldering station, i-TOOL with holder, IR heating plate, X-Y PCB table and EA 55 i solder fume extraction

### Health protection during soldering

- ▼ The breathing zone is very close to the soldering process during manual soldering, and the solder is added by hand. Thus there is the danger of contaminated air and hands or items which may have been touched
- ▼ Flux vapors can be damaging to the operator's health and should be kept out of the breathing area. Suitable devices for this purpose are solder fume extractions, which extract the smoke and associated vapors from the workplace and remove particles and gases. Modern fume extractions can be programmed to operate only when the soldering process is taking place, thus saving energy.
- ▼ One should never eat, drink or smoke in rooms where soldering is performed. Contaminations which remain on the hands can enter the human organism through food or cigarette smoke.
- ▼ Hands should be washed thoroughly after soldering.

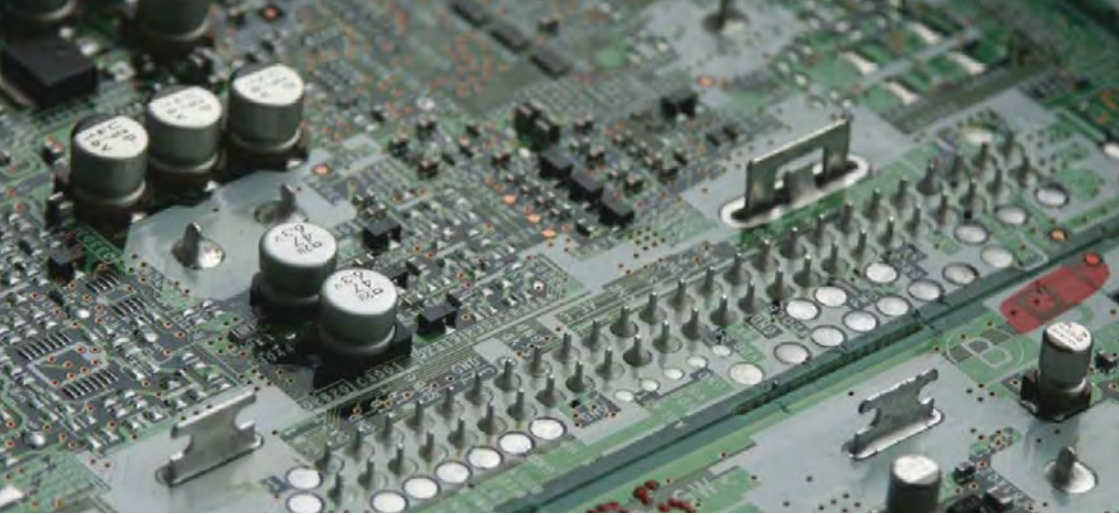

# Best solder quality

due to the right preparation and correct soldering parameters

## Preparation

The most important prerequisite for a good solder joint is absolute cleanliness. Conductor and component must be free of dirt, oil and oxides. They can be removed with solvents or flux.

Prior to soldering ERSADUR soldering tips should be cleaned while hot with a moist sponge or with a metallic dry sponge. Do not file the tip as you would copper tips, because this would damage the protective coating and render the tip unusable.

## Soldering process

The soldering process has three phases: wetting, flowing, and bonding, whereas the working temperature is the most important criterion. It is best to work at the lowest temperature at which the three phases can progress smoothly. This requires some experience. A



Wetting the soldering iron tip



Soldering a joint

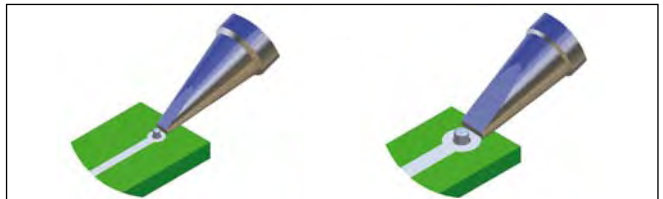

The selection of the right soldering iron tip is decisive for good soldering results

temperature-controlled soldering station will definitely facilitate this work. Place the tip on the joint to be soldered after cleaning and heat up the joint. Then feed the flux-cored solder tip and the joint and melt as much

solder as is required to wet the complete joint. Then remove the solder wire first and right after that the soldering tip to prevent overheating the solder. Allow the solder to solidify, avoiding any vibrations or jarring during this time.

## Soldering time

The soldering process should be completed within 2 to maximum 5 seconds with a correctly dimensioned soldering iron tip. When soldering electronic components with lead-free solders, experience

shows that more time is required. But even here requiring more than 5 seconds is not permissible, and it indicates that either the temperature setting is too low or the soldering iron lacks the necessary power.



## Solder joint quality

When the leads of the components mounted on the board are crimped, a good solder joint has been formed when the contour of the soldered lead is still visible. This will not be the case, if an excessive amount of solder has been used to form the joint.

A further quality attribute is the wetting angle. This consideration is based on the fact that good wetting of the pad, discernible through a small wetting angle, has given rise to the formation of a diffusion zone (intermetallic zone). Wetting angles of up to  $25^\circ$  identify a good joint, wetting angles of up to  $50^\circ$  are still tolerable in manual soldering.

Another quality indicator is what the solder surface actually looks like. It should be smooth and shiny, without any porous areas visible. Grainy surfaces indicate either overheating of the solder or an excessive soldering time. Using lead-free solders, especially silver loaded alloys, matt surfaces may form.

The only absolute quality indicator for a sound and strong solder joint is the formation of the diffusion zone. In the diffusion zone, intermetallic compounds of copper and tin are formed, whose presence is the final proof of quality (mixed crystals, see page 5). Unfortunately, the only way

to make this zone visible is through a destructive test (sectioning of the joint). If the diffusion zone is too thick, the solder joints have no tensile strength and become brittle. The higher the soldering temperature and the longer the soldering duration, the thicker the diffusion zone will be. Therefore the joint should be made at the lowest suitable temperature and within shortest soldering times.

As soon as the last solder joint has been made, the soldering iron is placed securely into the holder. At this time, the tip should not be cleaned, because the remaining solder on the tip prevents oxidization.

Correct!

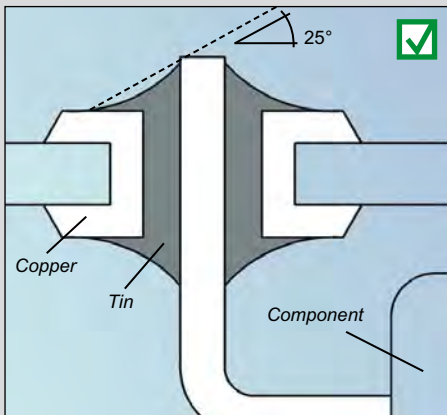

Wrong!

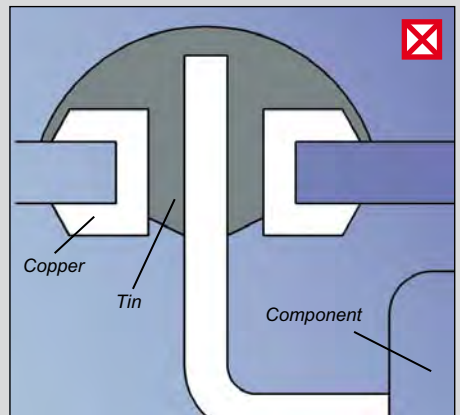



Desoldering with a solder wick

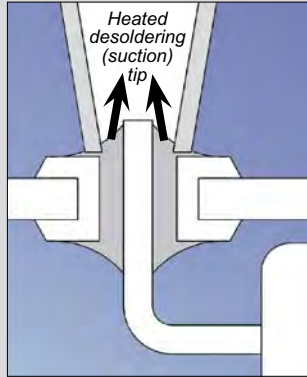

Desoldering with a temperature controlled soldering iron

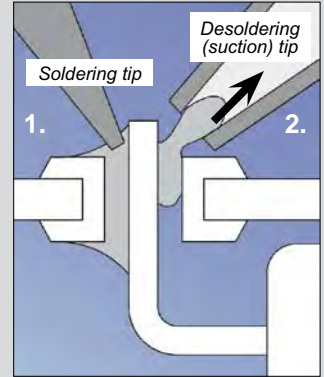

Desoldering with a desoldering pump

To achieve good results in desoldering, it is essential to select the right equipment. One can choose between desoldering wicks (desoldering using the principle of capillary action), mechanical desoldering pumps or electronic temperature-controlled desoldering systems. These are divided in desoldering systems with conductive heat or those with hot air.

## Correct desoldering made easy

The right tool for each application

### Desoldering

Reheating is not recommended for repairing a faulty solder joint. It is better to remove the solder and to resolder the joint. When using a desoldering pump, the solder joint has to be heated with the soldering iron until the solder has molten. Then the tip is removed and the desoldering pump is placed on the joint to extract the solder.

Using a heated desoldering tool, the hollow desoldering tip is placed on the joint to be repaired, making certain that there is good thermal contact. Once the solder has molten, it is extracted.

Desoldering is also dependent on proper tip selection. For example, the desoldering tip's inner diameter

should be the same size as the diameter of the through-hole or even slightly larger (by max. 0.3 mm, see above drawing). The best desoldering results with least damage to PCB or the components can be achieved with

temperature-controlled desoldering irons (also see pages 24/25). Please note that basically it has to be distinguished between the desoldering of through-hole components and the desoldering of SMD components.

Temperature-controlled desoldering iron



Sucking up the old, molten solder remnants with a mechanical solder sucker (desoldering pump)





Some examples of SMD components



## Ever smaller, ever finer

SMD technology, a true challenge

### SMD Soldering

SMD technology (Surface Mount Device Technology) is currently the standard process in electronics manufacturing. Ever smaller and highly integrated surface mount components place growing demands on SMD soldering equipment.

Single solder joints, for example on resistors, are made with ERSADUR long-life soldering tips starting with a diameter of 0.2 mm. Fine-pitch connections with a high pin-out, i.e. IC's, are most efficiently soldered with Ersas PowerWell soldering tips.

*Ersa PowerWell technology for soldering fine pitch components within seconds*

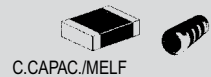
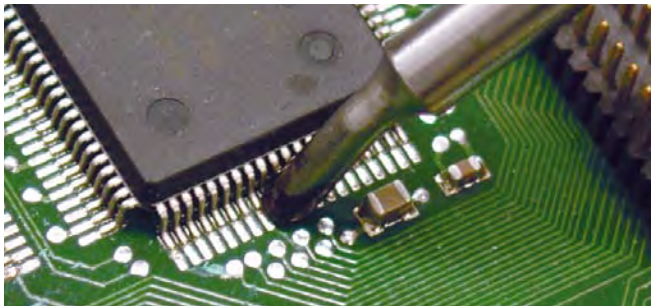

C.CAPAC./MELF



SOT&DPAK

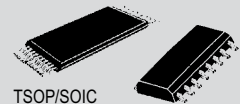

TSOP/SOIC



PLCC/LCCC

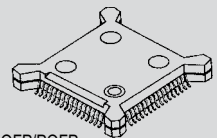

BQFP/PQFP

# Soldering fine-pitch components

## Process guide lines

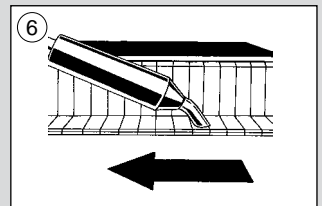
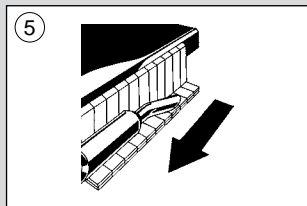
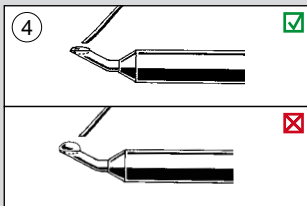
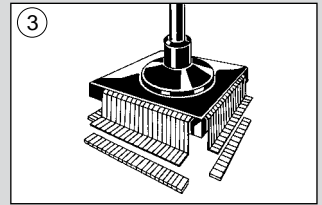
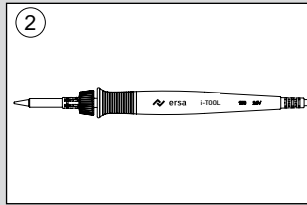
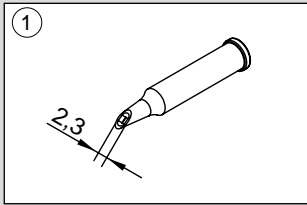

At first glance, soldering fine-pitch components by hand seems to be a tough job. Yet it is easy, with the right equipment at hand:

Insert an Erska PowerWell i-Tip (1) into the i-Tool soldering iron (2) and set a tip temperature of 285 °C to 360 °C (depending on the alloy used – tin/lead or lead-free).

Then position the component (3) and fix two corner pins.

Add flux cream (also see page 30) to the pins on all 4 sides. Clean the front and concave portion of the PowerWell tip with a damp sponge or the Erska dry sponge.

Fill the concave portion with solder to slightly above the rim by melting

the solder wire, until a small dome occurs (4). Take care not to add too much solder.

Place the i-Tool lightly on the flat section of the pins (5), and pull the tip across the pins towards you (6) without exercising pressure.

Repeat steps (4) to (6) to solder the remaining sides.

Good solder joint, sufficient solder and good fillet



Wrong: insufficient solder



Wrong: too much solder



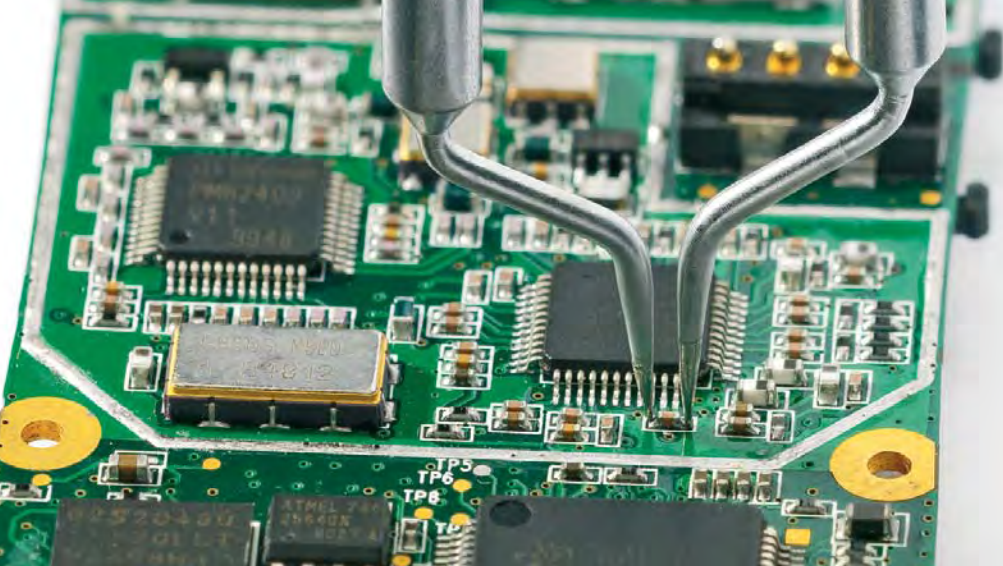

SMD desoldering in 3 seconds – with the Ersa desoldering tweezers

Some examples of different desoldering tip shapes: →



to desolder and remove MELF's



to desolder and remove SOIC's



to desolder and remove QFP and PLCC components

## SMD Desoldering

To desolder or rework a damaged SMD component, the suitable tools are required to remove the component from the board. When using a desoldering tweezer, it is extremely important to select the proper pair of desoldering tips. After having desoldered the component, the pad has to be cleared of the residual solder (e. g. with a suitable soldering tip and a no-clean desoldering wick). Afterwards the new component can be positioned and

soldered. An optional IR heating plate is a very useful addition - particularly in lead-free hand soldering applications.

More comprehensive instructions on SMD desoldering is available in the process description "SMD desoldering" on our website at [www.ersa.com](http://www.ersa.com). For the soldering and desoldering of BGAs or other high pin-out SMDs, particularly those with hidden joints, we recommend the semi-automatic Ersa rework stations (see page 31).

Solder melting and removal with a desoldering solder wick

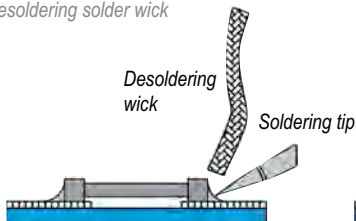

Ersa desoldering tweezers

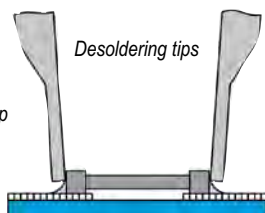

IRHP 200 infrared rework heating plate to assist in the soldering and desoldering process on multilayer boards or high-mass components



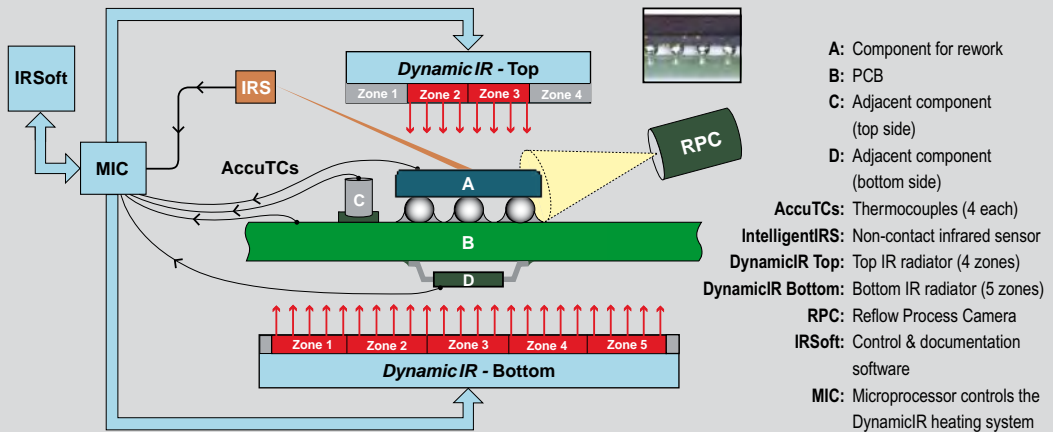

Principle of a rework station

# Rework or repair soldering

The rework process demonstrated on the example of a BGA (Ball Grid Array)

Rework designates the repair or touch-up of electronic components such as Ball Grid Arrays (BGAs) or SMTs. This chapter describes the process steps for BGA rework:

## 1. Desoldering the BGA

The rework station heats the PCB-board from the bottom, whereas the BGA body itself is heated from the top.

The real-time temperature of the component controls the pre-set temperature curve so that all solder joints melt at the same time. Then the vacuum suction cup is placed on the BGA and once all joints have molten the BGA is lifted off.

## 2. Removal of residual solder, cleaning

Solder remaining on the pads is removed with a soldering iron. To do so the residual solder is coated with flux. Then a flat soldering tip (e. g. 0102ADLF40 or 0102ZDLF150) is moved over the pad without applying any force. The solder adheres to the larger surface area of the tip, thereby levelling off the remaining solder of the connection pads. Flux residues are finally cleaned off (e. g. using Ersa Flux-Remover).

## 3. Reballing – Reusing the BGA

Desoldered BGA's can be refit with new solder balls and re-attached to the board. This process is referred to as reballing. Residual solder is removed from the BGA by means of a soldering station. Lying on

its back, the component is coated with flux first. Then the new solder balls are attached, for example by means of a stencil. These solder balls are heated up to the melting point with the rework station to firmly connect with the BGA body. Now the BGA is ready to be re-attached.

## 4. Application of flux or solder paste

The component and the connection pads are now fluxed, or, as the case may be, solder paste is added through stencil printing. The type of technique applied depends on the application, components and the skill level of the operators. For the commonly used PBGA's the application of flux is mostly sufficient.



## 5. Placing the component

Once the pad has been prepared, the component has to be placed. Since all solder joints of a BGA are hidden under the component body, a component placement unit is required. Successful visual placement by hand requires an operator with extensive experience and excellent skills. If the component is placed on solder paste deposits, great care has to be taken not to squash the solder depot, since doing so may lead to shorts after soldering.

## 6. Resoldering the BGA

The component is heated to the melting temperature of the solder alloy used via a controlled temperature curve. The heating continues until all solder joints have melted and remained so for some seconds.

During this time durable and lasting solder joints are formed. After resoldering, the board is cooled in a similar fashion as had been done after desoldering.

These process steps are generally applicable for all surface mount

components. Subject to the type of connections (wired, hidden) they may slightly vary.

*Rework – Repair of high-terminal count IC's to successfully repair SMT assemblies, the several points must be observed:*

- ▶ Dimensions and properties of the assembly have an influence on its temperature requirement
- ▶ PCB holders and supports keep the assembly flat and prevent warpage
- ▶ A gentle and controlled heating process, continuously monitored, prevents damage of components or the board
- ▶ Accurate component placement is a prerequisite for a good soldering result
- ▶ Operators that are well trained will understand the process and ensure good results

*Rework process steps*



1. Remove BGA



2. Remove residual solder from the pads of the board



3. Reballing – adding new solder balls



4. Application of flux or solder paste



5. Placement of the new or reballed component



6. Resolder the BGA on the prepared surfaces of the board

# Miniature soldering iron

Ersa Minor S



Minor S, 5 Watt



Ersa Minor S (5 W), a featherweight at 6 g for ultrafine soldering applications

The **Minor S** miniature soldering iron with a rating of 5 W and a maximum tip temperature of 440 °C is a ideal tool for ultrafine soldering applications on micro IC's and under a microscope. It can either operate with a 6 V transformer or a 6 V battery.

Besides electronics the Minor S can also be used in watch repair, in the photographic industry and in dental technology.

# Micro soldering irons

Ersa Multitip Series



Multitip serie, 15/25 Watt



Ersa Multitip (15/25 W) internally heated soldering iron for small to medium solder joints

The **Multitip** soldering irons are especially short, light and easy-to-handle soldering irons with minimal distance between soldering tip and the handle's front part. They are ideally suited for small solder joints. Its internally heated soldering tip provides an enhanced degree of efficiency.

The Multitip is available for 15 W and 25 W which makes it suitable for micro soldering joints and medium-sized joints, as for example, on distributor strips or in the hobby sector.

# Universal soldering iron

Ersa 30 S and Ersa Multi-Pro



Ersa 30 S, 30/40 Watt

Ersa Multi-Pro, 20 W



Ersa Universal Soldering Iron – for almost all applications

The proven **Ersa 30 S** available with 30 or 40 W rating is a very robust and durable soldering iron. Its improved ergonomics is further enhanced by the practical and detachable rubber clip-on support disk. This universal soldering iron is designed for multi-purpose use in the crafts, service and hobby sector.

The **Multi-Pro** with its heat resistant power supply cord is extremely flexible, as it can be operated with a wide range of different tips. Therefore, it is suitable for almost all conventional soldering applications.

# Standard and hammer soldering irons

Ersa 50 S, 80 S and 150 S / Ersa 200, 300 and 550



Ersa 50 S, 80 S, 150 S, 50/80/150 Watt

Ersa 200/300, 200/300 Watt

Ersa 550, 550 Watt

The **Ersa 50 S / 80 S or 150 S** series is designed for applications where a large amount of heating capacity is required, as, for example, on copper conductors with cross-sections of 2.5 mm to 6 mm.

The **Ersa 200, 300 and 550** hammer soldering iron series are particularly suited for sheet metal processing and installation work and for soldering commutators and copper bus bars. Hammer soldering irons have also proven their merit in leveling applications during body work and lead glazing.

# High speed soldering iron

## Ersa MULTI-SPRINT

The **Ersa MULTI-SPRINT** is an ergonomically designed and extremely light-weight, pistol-type soldering iron with up to 150 W power which does not require a transformer. Its PTC heating element, together with the internally heated ERSADUR long-life soldering tip, ensures its exceptionally high efficiency. Due to its very short heat-up time, it is ideally suited for making quick single soldering joints. The MULTI-SPRINT is powered only as long as the button is pressed. Depending on the heat requirement of the solder joint to be made, additional energy can be supplied by periodically pressing the button. The large variety of soldering



tips of the 832 / 842 series make the MULTI-SPRINT suitable for more than only the use in repair and service applications.



Ersa MULTI-SPRINT, 150/75 Watt

# Power soldering iron

## Ersa Multi-TC



Ersa Multi-TC, 75 Watt



The **Multi-TC** is a powerful, temperature-controlled soldering iron. A temperature sensor, located directly beneath the internally heated soldering tip, registers the actual temperature in the immediate vicinity of the solder joint. The heating system with the PTC heater element reacts immediately upon the loss of heat, replenishing the lack of heat instantaneously thanks to its excellent performance, and because of the large selection of soldering tips, the Multi-TC is highly suitable for all applications in the electronic industry as well as anywhere else where standard irons with 150 W power are in use.

# Gas soldering irons

Ersa INDEPENDENT 75 and INDEPENDENT 130



Ersa gas soldering irons are fueled with commercially available lighter gas and are fired up through the piezo ignition. Compared with electrical soldering irons, the **INDEPENDENT 75** has between 15 – 75 W, and the **INDEPENDENT 130** between 25 – 130 W performance. Both irons are available in the Basic-Set and Profi-Set versions.

Aside from handling the usual types of electronic components, the selection of tips available enables the Independent to also handle SMD soldering, micro-welding, forming and cutting of synthetic materials and the processing of shrink sleeves.

# The basic soldering station

Ersa ANALOG 60

The electronic temperature-controlled ANALOG 60 is Ersa's basic soldering station model. It has the tried and proven RESISTRONIC

temperature control technology with the PTC heating element serving as the temperature sensor. The high heat-up rating of 190 W

guarantees the immediate supply of heat and a heat-up time of 60 seconds from room temperature to 280 °C. The Basic Tool 60 soldering iron uses the internally heated ERSADUR long-life soldering tips of the 832/842 series and provides very high performance.

Due to the wide range of 832/842 soldering tips, the Ersa ANALOG 60, which is also available as an antistatic version, covers a wide range of applications with the most varied soldering requirements.



# Digital soldering station

Ersa RDS 80 – high performance for low cost

The digital soldering station Ersa **RDS 80** offers the proven and tested Ersa RESISTRONIC temperature control technology, now also with 80 W heating power. The ceramic PTC heating element (Positive Temperature Coefficient) acts as the temperature sensor in this control system. Due to its very high ramp-up capability of up to 190 W, the station reaches operating temperature very fast.

The high heating power and the extensive selection of soldering tips make the unit suitable for a broad range of applications. The heating



Multifunctional display



Potential equalization socket

system with the internally heated soldering tips delivers an excellent thermal performance.

The ergonomic handle, the functional housing design and the large digital multi-function display leave nothing to be desired. Aside from a freely selectable choice in temperature settings between 150 °C and 450 °C, three fixed temperatures or two fixed temperatures plus one stand-by temperature can be programmed.

The station also has a power bar graph display, a calibration and a power-off function. The potential

equalization socket (with an integrated 220 kΩ resistor) allows the soldering tip to be equalized with the workplace potential.



*RT 80: sleek soldering iron with a large selection of soldering tips*



# Multifunctional soldering stations

Ersa *i-CON NANO* and *i-CON PICO* – small, powerful and versatile



settings provide for a variable adjustment of operating temperature as well as the setting of stand-by time and calibration value.

Further adjustments such as fixed temperatures, power level, interlock and shutdown functions are available with the free PC software and an optionally available micro smart SD card.



Micro-SD card with SD-card and USB adapter

The youngest members of the *i-CON* product family, the ***i-CON NANO*** and ***i-CON PICO***, fulfill all the needs of today's electronic manufacturing while requiring minimal space. They are designed for continuous operation in the

electronic manufacturing environment as well as for special applications in laboratories and R&D departments.

Due to the simple and user-friendly operating concept, the factory

The concept of the Ersa *i-CON* stations ensures that each application is processed with the optimal parameters. They stand for the highest level of process safety and quality control at low investment and operating cost.

Ersa *i-CON PICO*



- ▼ Small footprint (145 x 80 mm) – saves valuable space
- ▼ Antistatic as per MIL-SPEC/ESA (only *i-CON NANO*)
- ▼ Three fixed temperature settings or continuously adjustable temperature settings from 150 °C to 450 °C
- ▼ Three selectable power levels
- ▼ Ultra-light and ergonomic soldering tool with max. 80 W power
- ▼ Wide range of low-cost exchangeable long-life soldering tips
- ▼ Automatic stand-by and sleep function for low energy consumption and longer tip life
- ▼ Password interlock for maximum process control
- ▼ Calibration function for a precise tip temperature
- ▼ Complete parameterization through PC software and Micro-SD card



# High-end soldering and desoldering stations

Ersa *i-CON1* and *i-CON2 / C* for highest productivity and process safety



Ersa *i-CON2* with *i-TOOL* and *CHIP TOOL*

the handle. This now allows for each individual *i-TOOL* to be calibrated independent of the soldering station.

In contrast to the concept followed by the cartridge type soldering tips, only the tip itself is exchanged at the *i-TOOL*. The cost intensive heating element remains.

The double iron soldering station *i-CON2* can be operated either with a second *i-TOOL* or with the SMD desoldering tweezers *Chip Tool* resp. with the desoldering iron *X-TOOL*.

The stations of the *i-CON* product family are Ersa's innovative solution for intelligent manual soldering. The need to be able to cope with higher working temperatures and with progressively smaller process windows when working with lead-free solders, poses no problem whatsoever for the *i-CON* product family.

The *i-CON* is available as a single station as well as double iron station.

The single station *i-CON1* is delivered together with the *i-TOOL* soldering iron. The *i-TOOL* is extremely small, ultra-light and ergonomic. It is powered by a 150 W micro heating element, which realizes short heat-up times (within 9 seconds up to 350 °C!) and rapid heat recovery.

The microprocessor which stores the temperature calibration of the iron is located in the PCB which is installed in

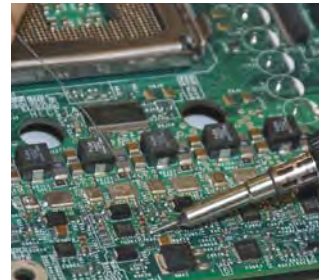

*Soldering miniature and densely placed SMD components with the *i-TOOL* and *i-Tips*, starting at a 0.2 mm diameter.*

*i-CON1* with *i-TOOL* soldering iron with high-performance micro heating element



- ▼ *i-TOOL* soldering iron with 150 W micro heating element technology
- ▼ Low-cost exchangeable long-life tips of the *i-Tip* series
- ▼ User friendly "One-Touch" operation
- ▼ Three power levels – no overshoot
- ▼ Process window and alarms
- ▼ Interface to control peripheral equipment on the workplace, such as heating plate and solder fume extraction systems
- ▼ Stand-by control for tools, heating plate and solder fume extraction system
- ▼ *i-TOOL* calibration
- ▼ Tools for SMT and conventional soldering applications
- ▼ Automatic tool recognition



# Top Tips

*i-Tips for all applications*



*Ersa i-TOOL: The ideal soldering iron – ultra light (only 30 g), ultra short (only 155 mm), and ultra short tip-to-grip (only 45 mm) and extremely powerful.*

The CHIP TOOL facilitates safe and quick desoldering, of the smallest chips up to large PLCC's. To remove the residual solder and to desolder wired components – also on multilayer boards – the X-TOOL desoldering iron is the right tool.



*High-mass through-hole desoldering with the X-TOOL*



*User-friendly controls: quick programming and interlocking, very large multi-functional display with i-Op controls, its menu is available in 7 languages. Online Help is available.*

The C-line of the *i-CON* stations was developed, so that peripheral equipment could be controlled or to communicate with them. Via a serial interface, the *i-CON1 C* or the *i-CON2 C* controls the Ersa IR heating plates or the Ersa solder fume extraction systems.

*i-CON2 C workplace with solder fume extraction EA 110 plus i and heating plate*

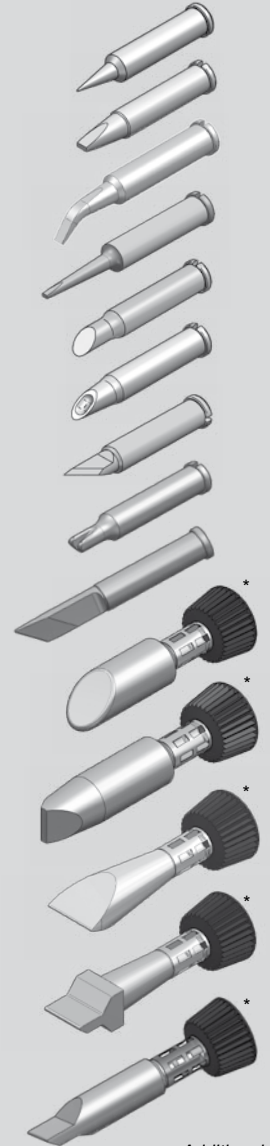

*\*Figure with i-Tip tip fastener*

*Additional soldering tips for the i-TOOL and the i-CON soldering stations is available on our web site:*

[www.ersa.com](http://www.ersa.com)

# Hybrid Rework Station

Ersa HR 100 A – The innovative combination of hot air and infrared radiation



The Ersa **HR 100 A** applies the Ersa Hybrid-Rework Technology for a safe desoldering and replacement of small SMD components. Its medium wave length IR radiation, combined with a safe stream of hot air ensures optimal heat transfer to the component.

This hybrid tool offers a gentle and homogeneous warming of all sizes of components, from 0201 chips up to 20 x 20 mm SMD's and larger. Exchangeable hybrid adapters target the thermal energy available (up to 200 W) on to the component, all the while protecting neighboring areas and not blowing away or moving adjacent chips.

Its user-friendly handling permits even operators with little experience to safely and efficiently operate the HR 100. More experienced operators, on the other hand, can not only variably adjust the air flow as well

as the heat output, but also record and run profiles. A positioning laser whose laser point makes it possible to keep track of the component worked on through the complete process is integrated in the grip of the ergonomic hybrid tool.



*Complete system with HR 100 A, IR heating plate, stand for Hybrid Tool and PCB holder.*



- ▼ Hybrid tool with 200 W heating element, positioning laser integrated in grip
- ▼ 3 exchangeable hybrid adapters (6 x 6 mm, 10 x 10 mm and 20 x 20 mm)
- ▼ Silent rework fan (below 40 dB)
- ▼ Integrated vacuum pump and vacuum pen; tool holder and K-type thermocouple input socket; USB interface; LED display
- ▼ 2 channel temperature recording:  
TC & IRS; AccuTC and Flexpoint thermocouple holder
- ▼ Tool holder with z-axis height adjustment
- ▼ x-y PCB holder (290 mm x 250 mm)
- ▼ 800 W IR heating plate with glass cover:  
125 mm x 125 mm IR high-performance heating element
- ▼ Rework profile and documentation software Ersa IRsoft

# Clean-Air solder fume extractions

Ersa EA 55 *i* and EA 110 *plus i* – protecting the environment, health and resources



Ersa EA 55 *i*

Ersa EA 110 *plus i*

The Ersa **EA 55 *i*** is a compact yet powerful filter unit to efficiently clean the process air at the work-place. Both *i*-CON1 C as well as *i*-CON2 C can be connected to the EA 55 *i* with an interface cable. The solder fume extraction has three filtration levels to remove noxious gases.

With the solder fume extractor **EA 110 *plus i***, Ersa offers the user a

further compact and highly efficient fume extraction unit for either one or two workplaces. One or two units *i*-CON1 C / *i*-CON2 C can be connected to the EA 110 *plus i* via interface cable.

Both models, the EA 55 *i* and the EA 110 *plus i*, are provided with a stand-by mode and operate only when the soldering units they are connected

to are being used. They are easy to install, can be placed very flexibly, and due to their very low noise level, they can be operated in virtually all environments, be it repair shops, development facilities or laboratories.

To accommodate different working conditions and applications. A variety of extraction arms and nozzle shapes which can be easily and quickly exchanged are available to meet different working conditions..

*Activated carbon absorbs dangerous gas molecules*

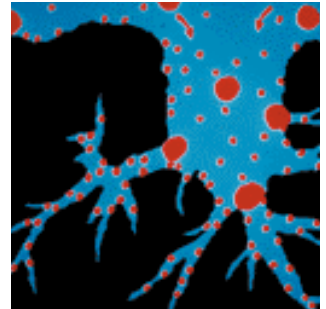

*The Clean-Air solder fume extraction unit EA 110 plus i can be connected to and controlled by one or two i-CON1 C / i-CON2 C through an interface cable, or through a manual stand-by switch*

*Ersa i-CON C – an interface controls everything: preheat, soldering, fume extraction.*



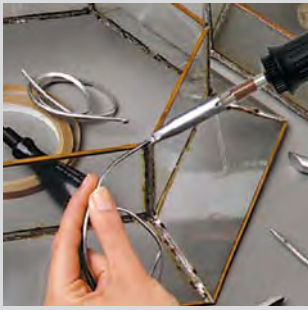

Tiffany soldering

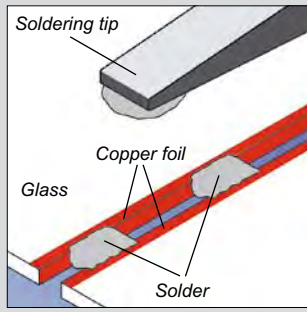

Step 1: spot soldering

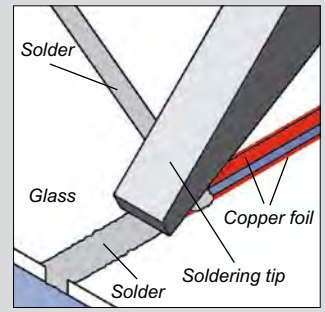

Step 2: rough soldering

## Tiffany or sheet metal soldering

Soldering beyond the field of electronics

### Tiffany soldering (Lead glass soldering)

Soldering a Tiffany object generally involves three individual steps:

- Spot soldering
- Rough soldering
- Finishing

Prior to the actual soldering process, copper foil is glued on the glass edges. The next step is spot soldering,

i. e. the glass parts are fastened or connected by taking a drop of solder with the tip of the soldering iron and carefully applying it to the solder joint. Each spot soldering operation should only take about a second. During rough soldering the gap between the glass is filled with solder after flux has been applied. For this purpose the tip and solder are moved together along the joint. Always drag the soldering iron, never push it. Only if

this procedure is accurately followed, and if a sufficient amount of solder is applied, the desired, half-round and convex seams are achieved. The lack of visual quality of the seam at this stage is optimized during the finishing soldering step, in which the soldering tip is dragged slowly and from the beginning of the seam until the end at an even speed. The seam worked on should always lie flat on the bench.

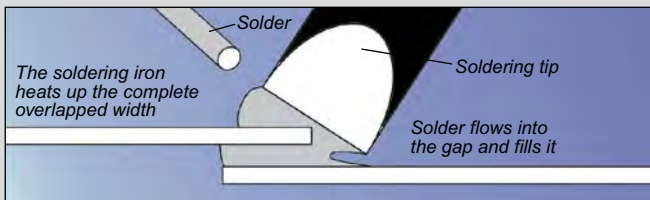

Guiding the soldering iron when soldering a broad seam



Guiding the soldering iron when soldering a narrow seam

### Plumbing and tinsmith work

For the joining of sheet metal and metal pipes, the joints to be soldered have to be bare. This calls for a good prior cleaning.

After this, the flux – either solder grease or solder fluid, a zinc chloride solution – is applied. Then the area to be soldered is heated with the tip of the soldering iron.

Once the solder area is sufficiently hot, solder is added and the solder gap is filled.

The aggressive flux residues are removed after cooling to avoid the risk of future corrosion.

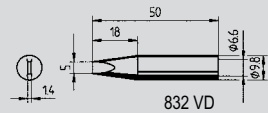
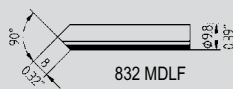
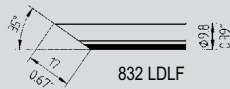
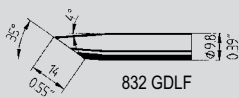

## ERSADUR Tiffany soldering tips

The types VD, GDLF, LDLF and MDLF of the comprehensive 832 tip series are particularly suited for Tiffany work. On account of their

shapes and their high mass (excellent because of the ensuing heat retention capacity), the seams between the glass parts can quickly

and easily be filled with solder. And the ERSADUR finish warrants a long tip lifetime.

# ERSADUR Tiffany soldering tips

Ersa DIGITAL 2000A, Ersa Multi-TC and ERSADUR soldering tips

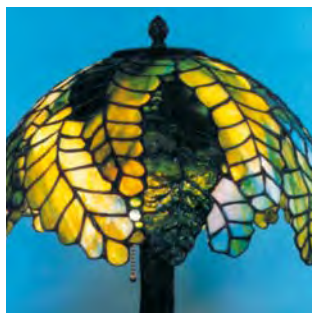

Tiffany lamp

The **Multi-TC** soldering iron is very light, robust and powerful. The Ersa-SENSOTRONIC-Control with the PT-1000 temperature sensor in the tip reacts immediately when heat is withdrawn.

The Multi-TC is provided with a 2.2 mm wide, chisel-shaped soldering tip. Together with the Tiffany soldering tips, the slim Multi-TC is superbly suited for the use in Tiffany work.

Due to its precise temperature control, the **DIGITAL 2000 A** soldering station completely eliminates the

possibility to overheat any glass components or the copper foil, and the station has tremendous power reserves, making it comparable and putting it on an equal level with unregulated 150 W soldering irons.

The Ersa-SENSOTRONIC control with its internally heated soldering tip, where the temperature sensor is mounted directly below the tip, provides for precise temperature control and ensures uniform temperature levels at the soldering joint.

The long-life ceramic PTC heating element provides up to 290 W heat-up rating which means that the powerful soldering iron is ready for use in only 60 seconds.

The DIGITAL 200 A is provided with a 2.2 mm wide, chisel-shaped soldering tip. Particularly good results are achieved with the optionally available tip versions 832 VD, 832 GDLF, 832 CDLF and 832 MDLF, which are specifically offered for Tiffany applications.



Ersa Multi-TC, 75 Watt



Ersa DIGITAL 2000 A mit POWER TOOL

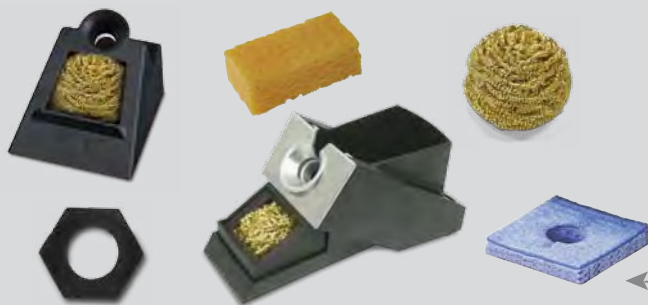

*Ersa tool holders or rubber clip-on supports to safely and ergonomically put down the soldering iron during work stoppages or during heat-up.*

*Ersa viscose cleaning sponges for moist or special metal wool for dry cleaning of the hot soldering tip prior to the soldering process.*

## Auxiliary products and practical accessories

Everything for your soldering needs from one source



**Ersa solder baths**



**Ersa solder wire and solder wire dispenser**



**Ersa DTM 100 temperature measuring device**



**Ersa tip exchanger**



**Ersa desoldering wicks**



**Ersa Soldapult desoldering pump**



**Ersa VAC X desoldering pump**



**Ersa SMD flux and flux cream**



**Ersa Flux Remover**



**Ersa Tip Reactivator**

Further peripherals and accessories can be obtained from your local Ersa distributor and at [www.ersa.com](http://www.ersa.com). Or just ask for our catalog!

# IR rework stations

Ersa IR/PL 550 and IR/PL 650 – from mobile phone boards up to XXL boards



Ersa IR/PL 650

More than 5,000 customers worldwide use Ersa's patented IR-Rework technology.

Ersa rework stations deploy the DynamicIR Heating Technology, programmable top and bottom

heating zones as well as the accurate, user-friendly and motorized Auto-Pick-and-Place feature. System control, process documentation and visualization is handled by the Ersa Rework software IRSoft.

# Optical solder joint inspection

ERSASCOPE inspection systems – the patented original



Since its introduction over 10 years ago more than 3,000 customers worldwide profit from the possibility, to non-destructively inspect hidden solder joints.

Regardless of whether the joints are under a flip-chip, or whether

areas are to be inspected where other microscopes have come to their limits – the ERSASCOPE technology offers a considerable added value to any quality assurance program!

# Ersa Know-How Seminars

Expert knowledge for professional users comprehensively imparted



Today more than ever, cost-effective production and highest quality in the electronic manufacturing industry is the basis for profitable competitiveness. A key ingredient for being competitive is a well-qualified staff, which is up-to-date on current technology and process.

Ersa Know-How Seminars are ideal for transmitting this knowledge to

those of your staff members with process responsibility in electronic manufacturing. In these seminars, theoretical and practical knowledge is presented in a neutral fashion in workshops and presentations by reputed experts in their field.

For further information go to our website [www.ersa.com](http://www.ersa.com) and click "Events".

# Ersa Electronics Production Equipment



Technical data and further detailed information on our range of hand soldering equipment is

available in our „Soldering Tools“ catalog. This is available in printed form and as PDF, as are the “Rework & Inspection” catalog.

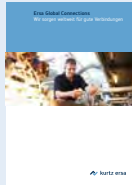

Aside from the extensive selection of hand soldering tools, rework stations and inspection systems for

non-destructive inspection, Ersa, as Europe's largest manufacturer of soldering systems, also offers a complete range of selective, wave and reflow soldering systems, as well as stencil printers for the industrial electronic manufacturing industry.

Please refer to our brochures and our website [www.ersa.com](http://www.ersa.com) for further information.



## Ersa GmbH

Leonhard-Karl-Straße 24  
97877 Wertheim/Germany  
Tel. +49 9342 800-0  
Fax. +49 9342 800-127  
[info@ersa.de](mailto:info@ersa.de)  
[www.ersa.com](http://www.ersa.com)

**grothusen**  
electronic systems

## Grothusen Electronic Systems Vertriebs GmbH

Albert-Schweitzer-Gasse 5  
A-1140 Wien  
Tel. +43 1 97022-0  
[strohmer@grothusen.com](mailto:strohmer@grothusen.com)  
[www.grothusen.com](http://www.grothusen.com)

 **bleuel**  
electronic ag

## Bleuel Electronic AG

Zürcherstr. 71  
CH-8103 Unterengstringen  
Tel. +41 44 751 7575  
[info@bleuel.ch](mailto:info@bleuel.ch)  
[www.bleuel.ch](http://www.bleuel.ch)

 **kurtz ersa**